



Dessinez vous-même votre aire de jeux

Découpez, positionnez, visualisez... C'est facile de donner vie à votre future aire de jeux !

Vous avez à votre disposition :

- ➔ 2 plans quadrillés (pages 39 et 40), avec des carreaux à l'échelle 1/100^{ème}.
Un carreau de 5 x 5 mm = un espace réel de 50 x 50 cm
- ➔ Des vignettes produits à découper (page 41 et 43) - Echelle 1/100^{ème}



1 Dessinez au crayon la zone réservée à votre espace de jeu.

Indiquez où se situent les points d'accès, les éléments de végétation.
Indiquez les points cardinaux Nord et Sud.

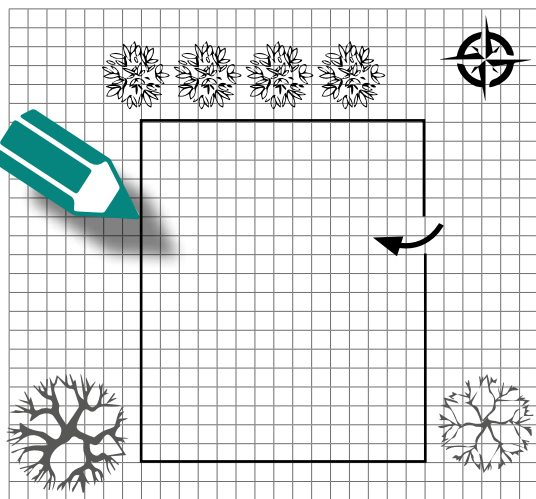

2 Découpez les produits que vous avez sélectionnés.

Découpez-les en suivant le pointillé le plus à l'extérieur.
Le pointillé intérieur, au contour épais, symbolise la zone de sécurité (cf page 35).

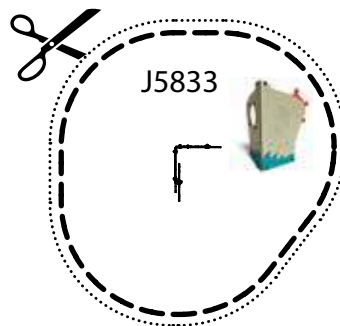

3 Positionnez les vignettes découpées sur le plan quadrillé, dans l'espace défini.

Tenez compte des conseils d'aménagement énumérés en pages 34 & 35.

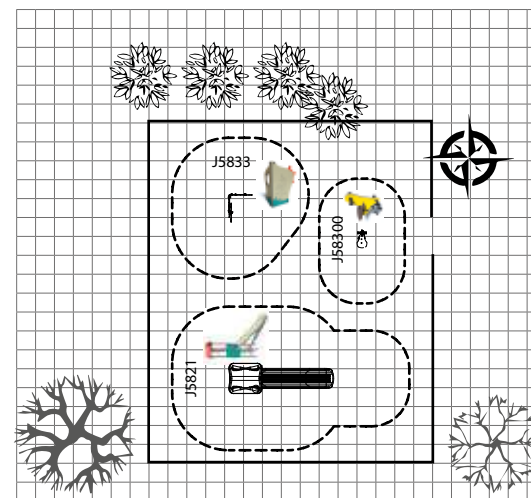

SUGGESTION !

Utilisez le quadrillage du plan pour déterminer le nombre de dalles nécessaires à l'installation de votre aire de jeux.
La dimension standard d'une dalle amortissante est de 50 X 50 cm (soit un carreau sur le plan quadrillé).

Comptez, additionnez, multipliez... vous obtiendrez le nombre de dalles à commander.

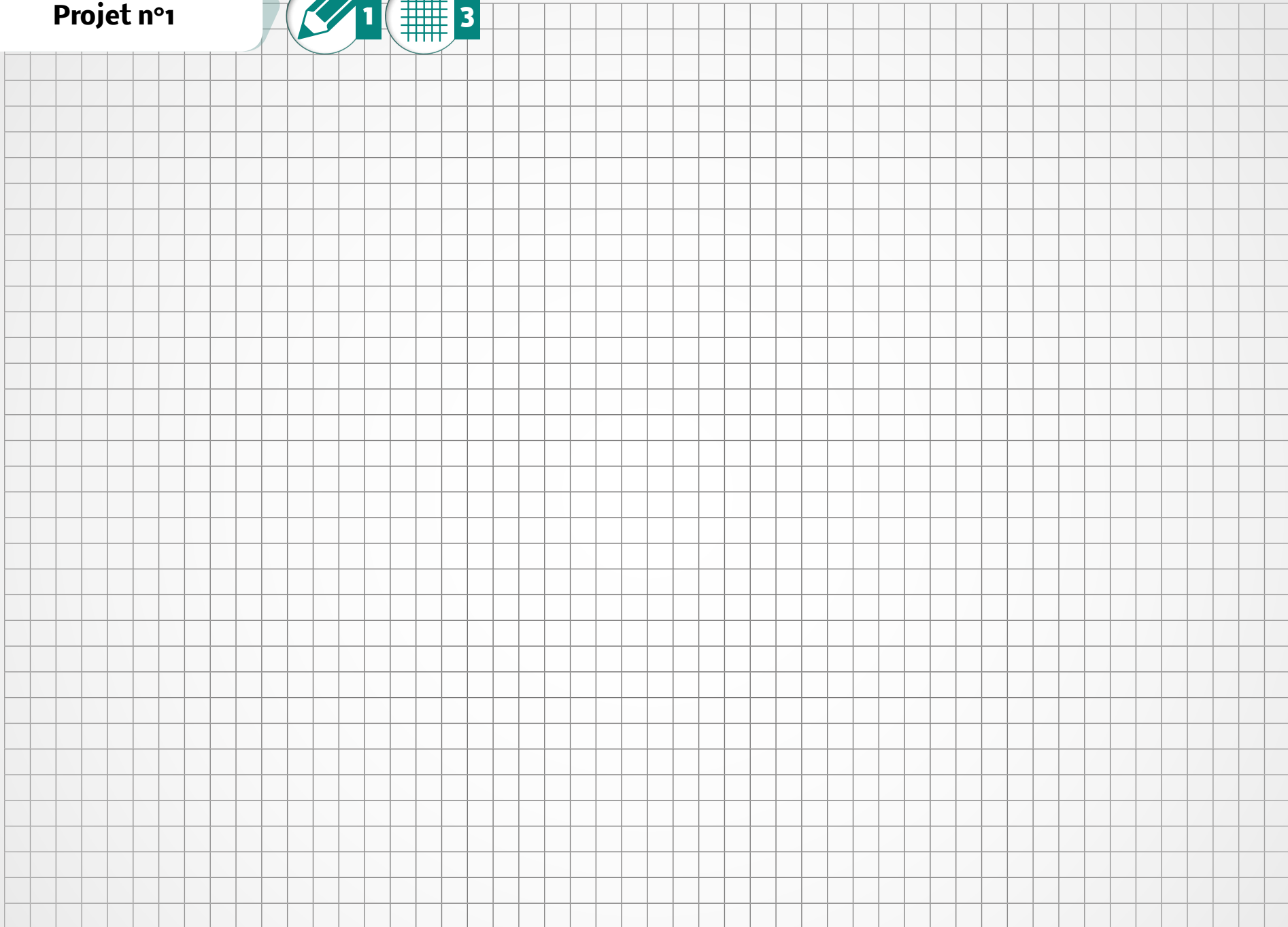

Projet n°2

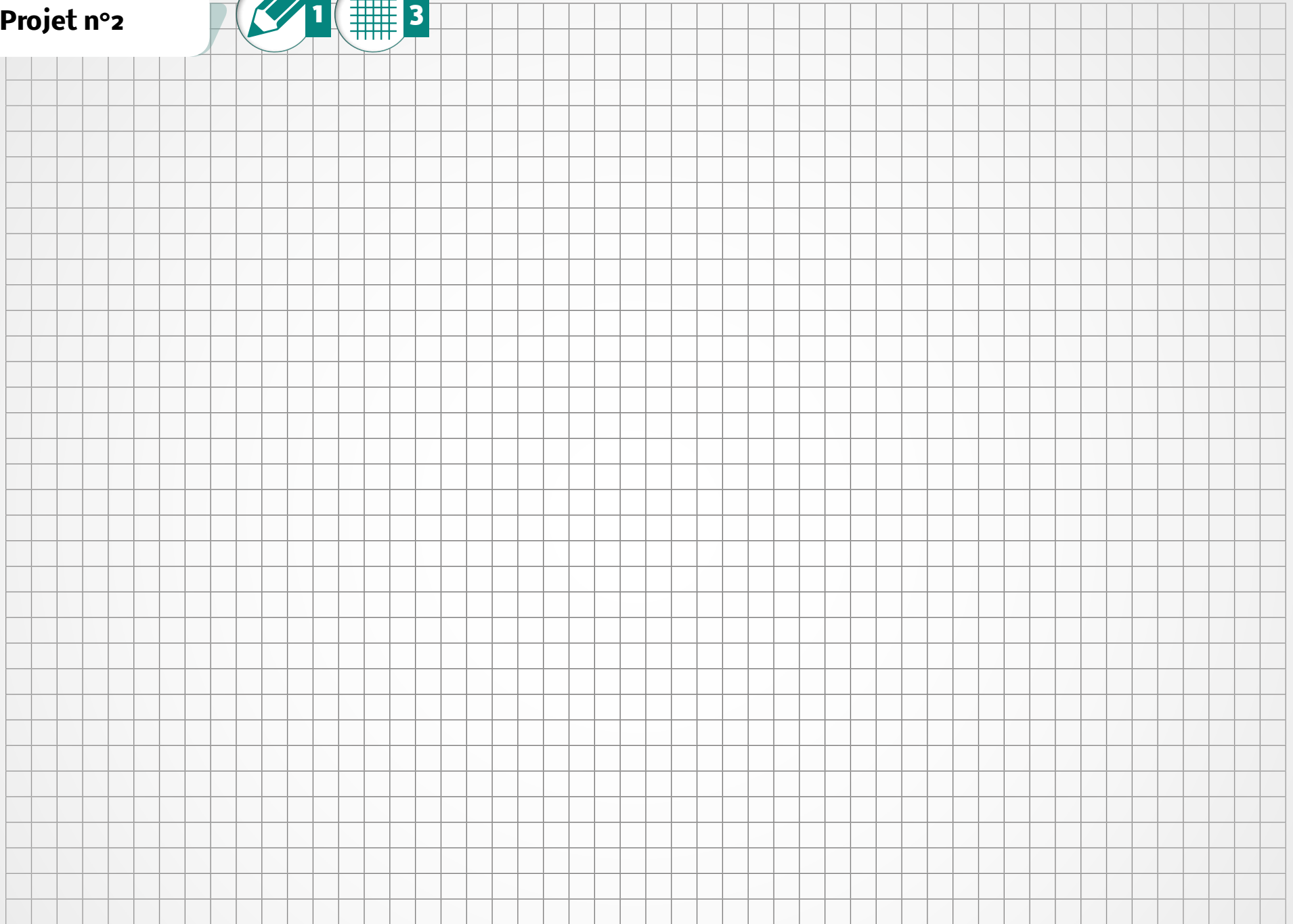



Découpez les produits que vous avez sélectionnés.

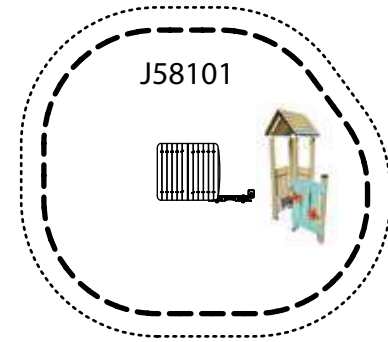
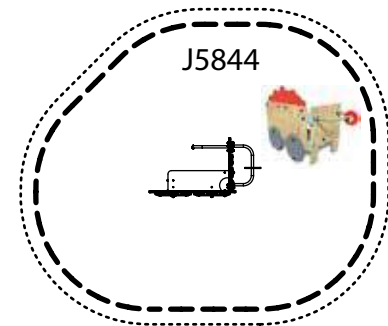
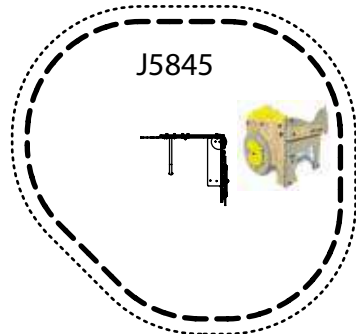
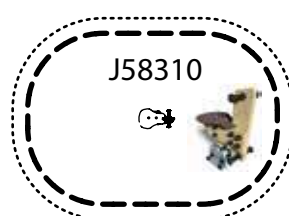
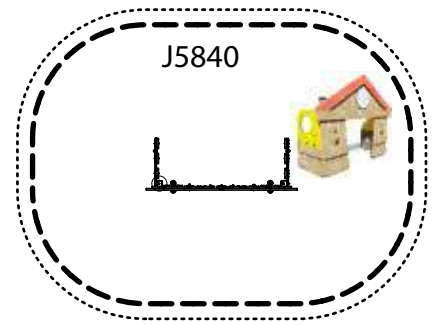
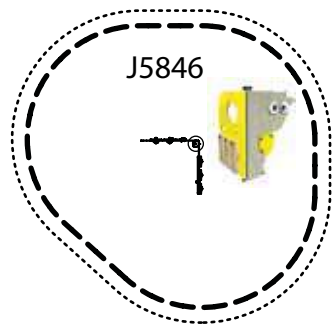
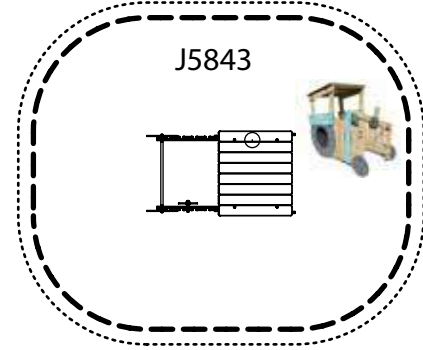
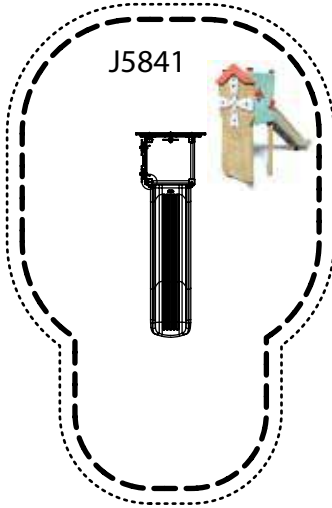
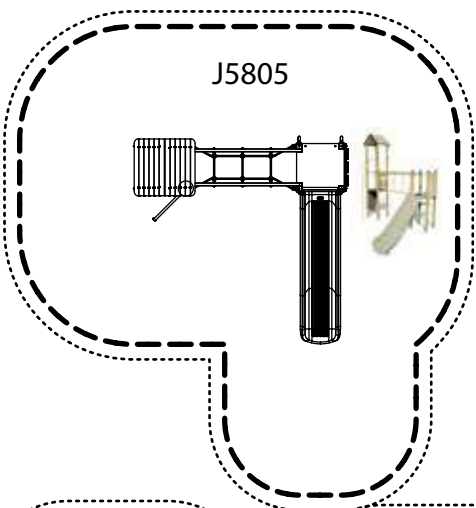
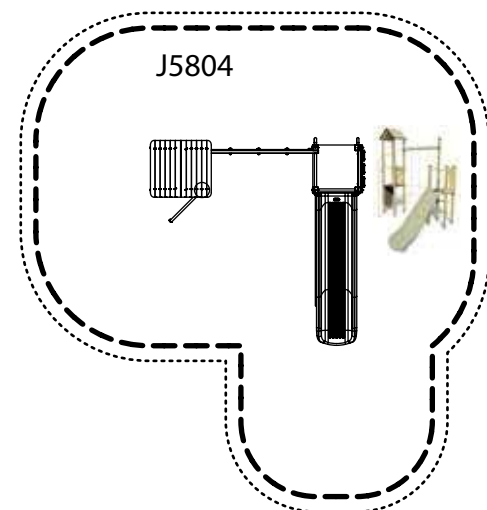
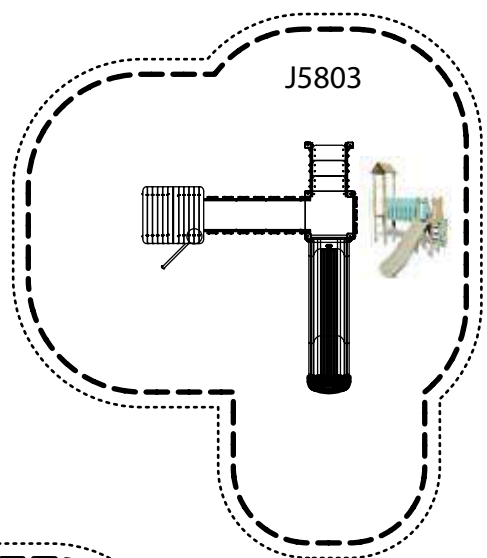
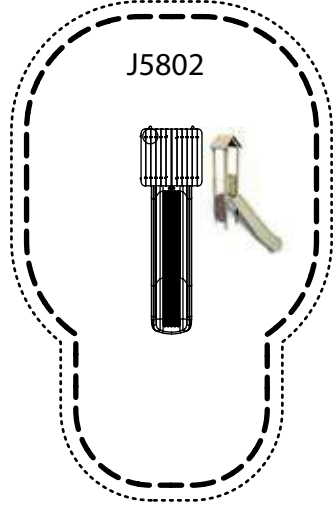
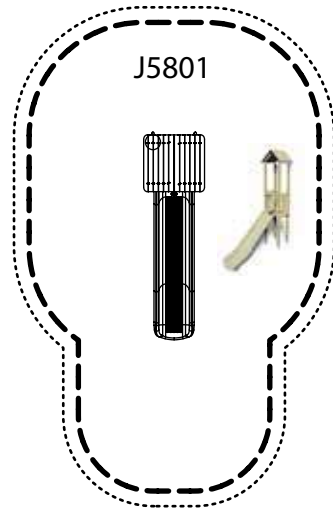
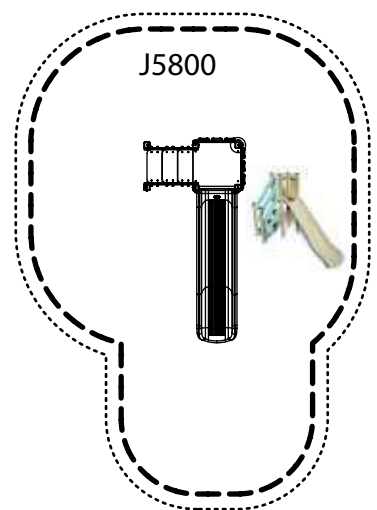



Jeux complémentaires

J58201

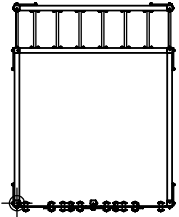

J58220

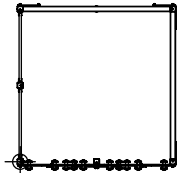

J58450



J58550

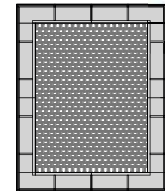
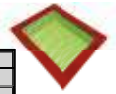

J58400

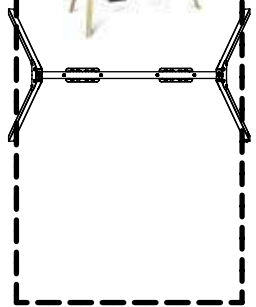

J5870



J58100



J5880

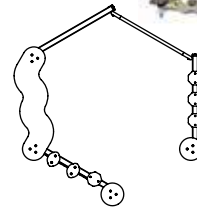

J58102

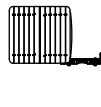

Découpez les produits que vous avez sélectionnés.

J5820

J5821

J5822

J5823

J5824

J5825

J5830

J5831

J5875

J5832

J5834

J58300

J58301

J58302

J5835

J58122



Jeux complémentaires

